

# eMMC NANDrive™

85VM Series

Product Brief

## Product Description

The eMMC NANDrive™ family of embedded solid state drives (SSDs) integrate Greenliant's advanced eMMC controller with one or more NAND flash die in a multi-chip package. eMMC NANDrive is available with 2-bits-per-cell (MLC) or 1-bit-per-cell (SLC) NAND to meet customer requirements for lifespan, endurance and performance. Greenliant's high-reliability SLC NANDrive products use industry leading EnduroSLC™ Technology to address the most demanding embedded applications.

Ideal for automotive, industrial, medical, security and networking applications, eMMC NANDrive is compatible with NXP, NVIDIA, TI, Intel, AMD and other popular chipsets. It operates between -40 and +85 degrees Celsius, giving customers data storage that can withstand extreme conditions. Available in both 100-ball and 153-ball packages and in multiple capacities, these space-saving products are designed with enhanced data integrity and security features.

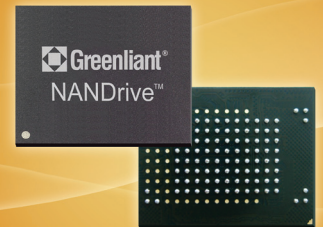

[www.NANDrive.com](http://www.NANDrive.com)

## Key Features

### Industry Standard eMMC Interface

- Supports JEDEC eMMC 5.1 (JESD84-B51) and 4.4 standards (JESD84-A44)
- Backward compatible with previous eMMC versions above revision 4.2

### Wide Range of Products

- Multiple capacities available with 2-bits-per-cell (MLC) or 1-bit-per-cell (SLC) NAND to meet endurance, data retention requirements
- SLC NANDrive SSDs with 50K, 100K, 250K endurance enabled by Greenliant's proprietary EnduroSLC Technology

### Power Management

- Supports auto-sleep mode
- Immediately disables unused circuitry without host intervention
- Dedicated pin (PD#) for power fail protection
- Integrated voltage detector

### High Performance\*

- Sequential Read / Write Performance up to 135 MB/sec / 95 MB/sec<sup>‡</sup>
- Supports HS200 / HS400 modes
- Clock speed up to 200 MHz
- Supports Dual Data Rate (DDR) modes
- High Priority Interrupt (HPI) helps prioritize important host requests

\*supported by eMMC 5.1 ‡measured in HS200 mode

### Robust Firmware

- Implements advanced global and group wear leveling to maximize product lifespan
- Embedded flash file system (FFS) enables seamless capacity migrations with no change to host software

### Built-in ECC

- Uses advanced hardware engine to detect and correct bit errors

### Bad Block Management

- Replaces bad blocks with spare blocks in the NAND flash before uncorrectable errors occur

### Data Security

- Permanent, temporary and power-on write protection for entire device and specific partition
- Dedicated pin (WP#) for write protection
- Supports RPMB / Sanitize / TRIM for sensitive data protection\*

### Latency Management

- Reduces latencies due to background operation during time critical read/write operations

### Package Options and I-temp Capability

- 100-ball LPGA package with 1mm ball pitch for increased long-term reliability
- 153-ball LFBGA package with .5mm ball pitch
- Industrial operation: -40°C to +85°C

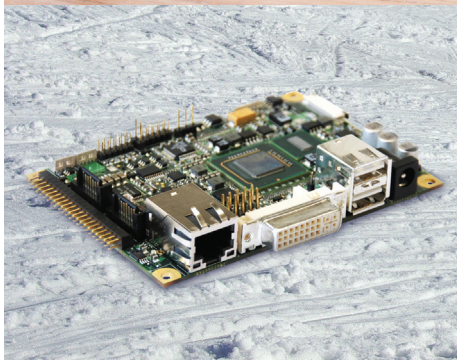

## Applications

- In-vehicle infotainment
- GPS and telematics
- Data recorder
- Video conferencing
- Tablet PC
- Multi-function printer
- Point-of-Sale terminal
- VoIP system / PBX
- Wireless base station
- Router / Gateway / Switch
- Set-top box
- Industrial PC / Single-board computer
- Ultrasound and medical imaging
- Industrial automation and control
- Test and measurement equipment
- Video surveillance / ID terminal

**Greenliant Systems**  
 3970 Freedom Circle, Suite 100  
 Santa Clara, CA 95054 USA  
 Tel. 1-408-200-8000  
 Fax 1-408-200-8099

[www.Greenliant.com](http://www.Greenliant.com)

## eMMC NANDrive Package Diagrams

153-ball LFBGA package  
11.5mm x 13mm  
Pb-free (RoHS compliant)

BOTTOM VIEW

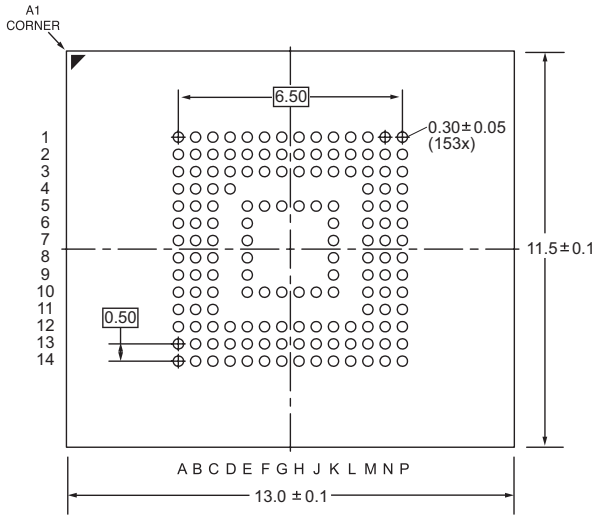

DETAIL VIEW

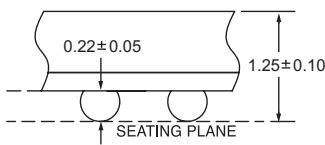

100-ball LPGA package  
14mm x 18mm  
Pb-free (RoHS compliant)

BOTTOM VIEW

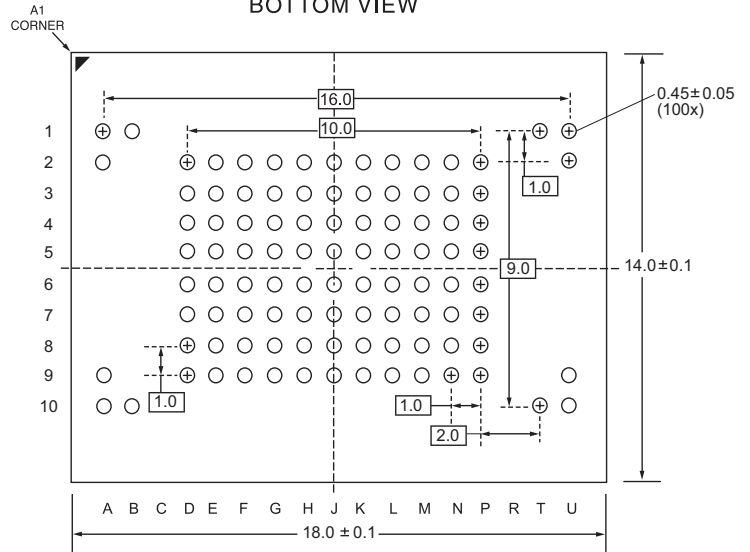

DETAIL VIEW

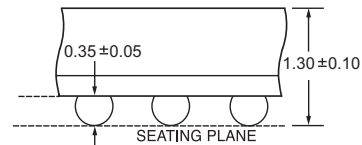

## eMMC NANDrive Block Diagram

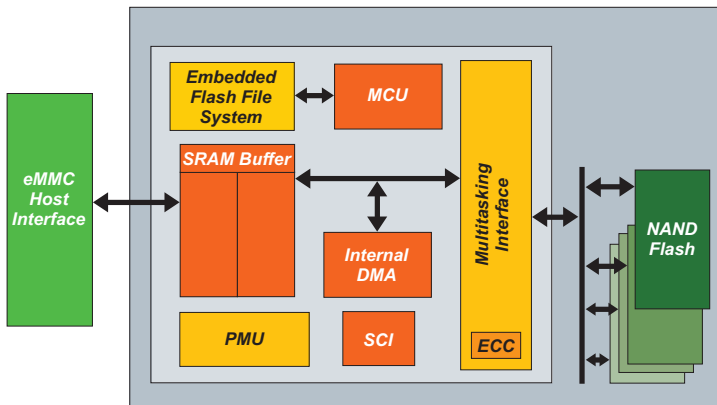

## eMMC Product Lineup

85VM Series eMMC NANDrive				
eMMC Standard	Capacity	NAND Configuration	Package Type	
4.4	512 MB – 1 GB	1 bit per cell (SLC)	100-ball LPGA 14 x 18 x 1.4mm	
	4 GB	1 bit per cell (SLC)		
	8 GB – 64 GB	2 bits per cell (MLC)		
5.1	2 GB – 4 GB	1 bit per cell (SLC)*		153-ball LFBGA 11.5 x 13 x 1.35mm
	8 GB	2 bits per cell (MLC)		
	2 GB – 32 GB	1 bit per cell (SLC)*		
	8 GB – 64 GB	2 bits per cell (MLC)		

\*Enabled by Greenliant's advanced EnduroSLC Technology

**EnduroSLC™**

# ASTUTE

twitter.com/Greenliant

linkedin.com/company/Greenliant-Systems

facebook.com/Greenliant

**Greenliant®**

NANDrive FAQs: [www.greenliant.com/nandrive-faqs](http://www.greenliant.com/nandrive-faqs)

Evaluation Boards: [www.greenliant.com/nandrive-eval-boards](http://www.greenliant.com/nandrive-eval-boards)

Long-Term Availability: [www.greenliant.com/support/#LTA-program](http://www.greenliant.com/support/#LTA-program)

For more information, contact [mick.martin@astute.global](mailto:mick.martin@astute.global)

© 2019 Greenliant

Greenliant, the Greenliant logo, EnduroSLC and NANDrive are trademarks of Greenliant.

These specifications are subject to change without notice. 01/2019